









# ItalCart

## Classic Gelato Push Cart

Gelato cart with ventilated refrigeration. One piece body with ecological polyurethane insulation (HCFC & HFC free), foamed with CO2. Tempered curved glass structure. Internal tank in stainless steel. This cabinet can be fitted with a double level of ice-cream containers 4 23/32h. Sun curtain with side supports in tubular stainless steel. 2 ray wheels and one pivoting wheel. Handle in tubular stainless steel for an easier handling.







	<b>REFRIGERANT</b>	R404A
	<b>ENERGY SAVING</b>	Led
	<b>INSTALLATION</b>	Plug-In
	<b>PRODUCT TEMPERATURE</b>	3,2 / 6,8 °F
	<b>DEFROST</b>	Hot gas
	<b>CLIMATIC CLASS</b>	4 [86 °F / 55% R.H.]
	<b>REFRIGERATION</b>	Ventilated
	<b>CLOSING SYSTEM</b>	Tilting panel

### STANDARD MODEL INCLUDES:

- Operator side closure with pivoting methacrilate panel system
- Work top in stainless steel
- Electronic control panel
- Swivel caster [1] with brake
- Led lighting
- Scoop washer
- Water tap
- Tanks

### COLORS

Yellow Graphic	White RAL 9003	Brown Graphic	Black
			
[Standard]			



Piled up double row

5 lt (Large)  
14 3/16 x 6 1/2 x 4 23/32h

# ItalCart

## Classic Gelato Push Cart

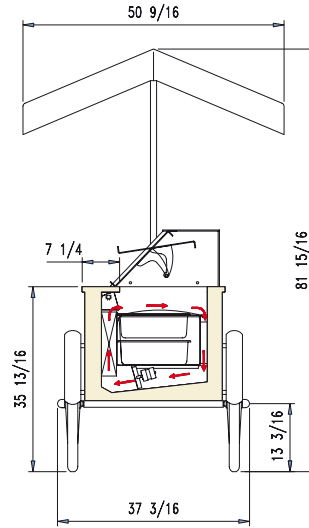
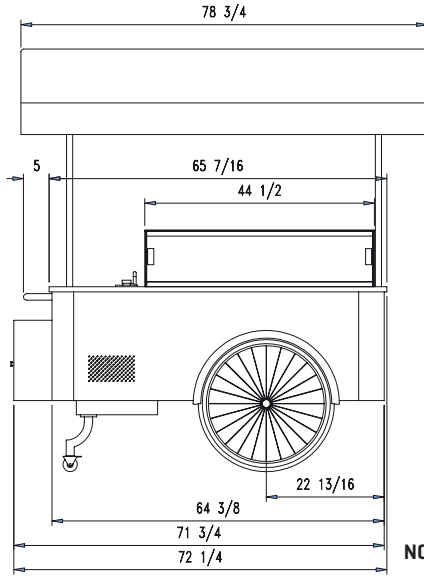

**NOTE:** The model does not include stainless steel containers.

TECHNICAL FEATURES			Classic
External dimensions	Lenght	inch	78 3/4
Capacity	Gross / Net	liters	260 / 104
Weight	Net	lb	452
Refrigerant			R404A
Product temperature		°F	3.2 / 6.8
Compressor	Type / Q.ty		Hermetic / 1
Defrost			Hot gas

STAINLESS STEEL CONTAINERS			Classic
4,75 lt [Standard]	10 1/4 x 6 3/16 x 6 11/16h		10
5 lt [Large]	14 3/16 x 6 1/2 x 4 23/32h		6 + [6]

ELECTRICAL DATA			Classic
Power supply			115 / 60 2 pole - 3 wire grounding
Nema plug			5-15P
Electrical input	A		7,2

Technical info refers to models with built-in air cooled condensing unit.

PACKAGING STANDARD [Carton + pallet]			Classic
External dimensions	Lenght	inch	75 3/16
	Depth x Height	inch	29 29/32 x 41 11/32
Gross weight		lb	510



Distributed by:  
 GTI Designs  
 35 Trade Zone Court  
 Ronkonkoma, NY 11779

Tel: 800-896-4484  
 631-981-2100  
 CustomerService@gtidesigns.com  
 www.gtidesigns.com